

INSPIRE 3D SCANNER

Quick Start Guide V1.0

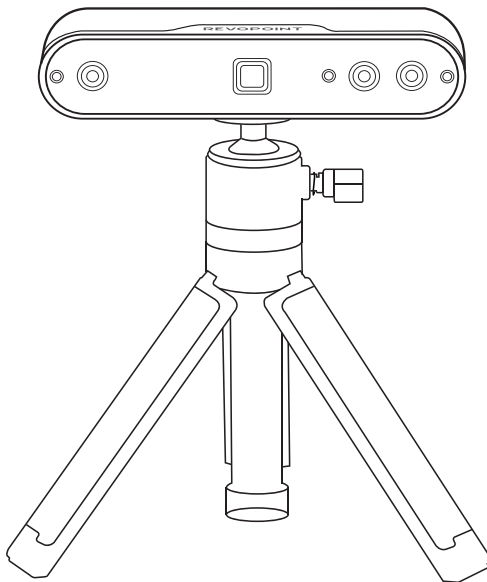

REVOPOINT

Contents

About INSPIRE	02
What's in the Box?	02
Software Download	03
Scanner Connection	03
Connect INSPIRE to a PC via USB	03
Connect INSPIRE to a Phone via Wi-Fi	05
Mini Turntable Connection	07
Setup the Scanning Environment	08
Introduction to Revo Scan 5	09
Scanning Workflow	09
Post-processing	12
Export the Model	12
Online Support	13

About INSPIRE

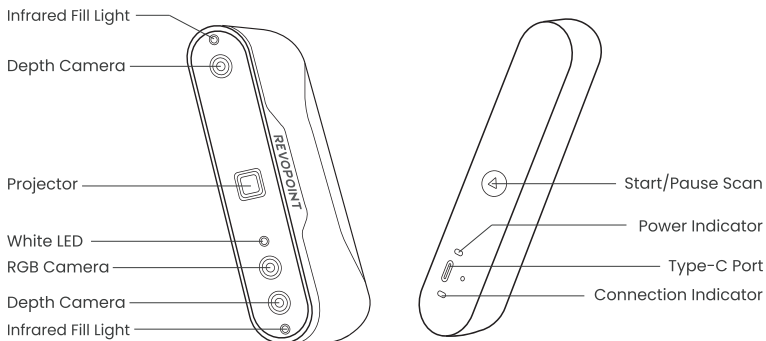

What's in the Box?

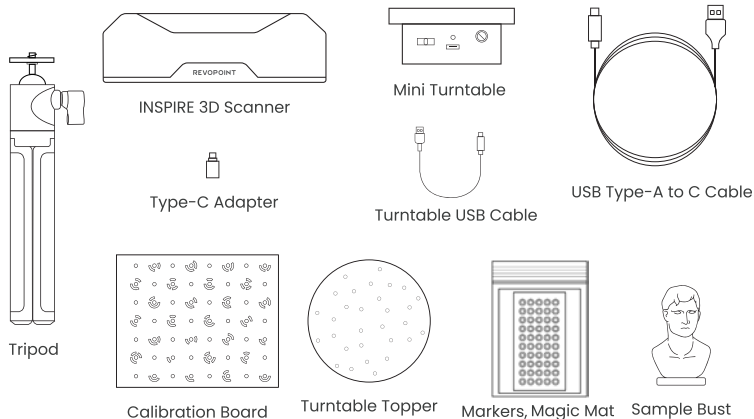

Software Download

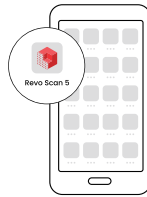
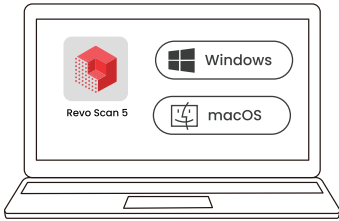

Download it at
www.revopoint3d.com/download/

Scanner Connection

Connect INSPIRE to a PC via USB

1

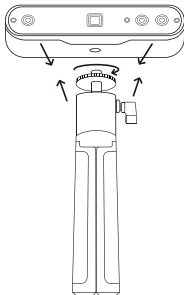

2

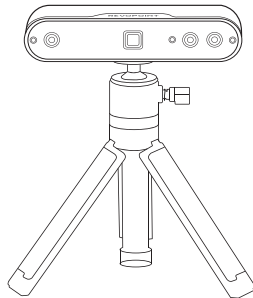

3

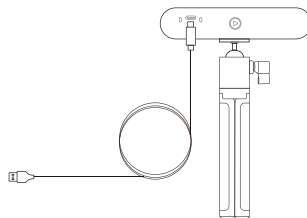
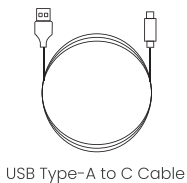

4

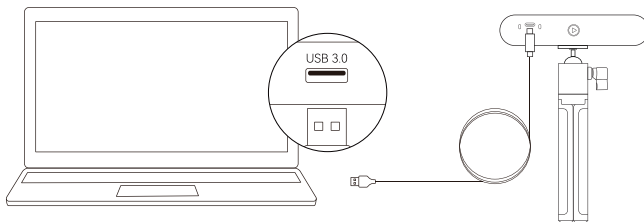

Or Using the Type-C Adapter

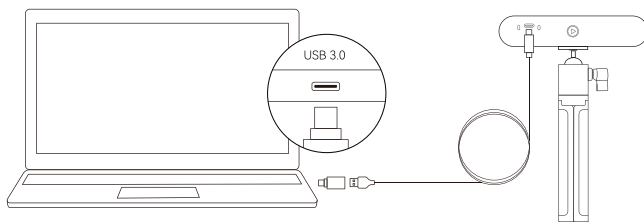

- Connect INSPIRE to a USB 3.0 port or above (USB 2.0 will not supply sufficient operating power). Ensure your USB 3.0 port is not damaged or worn out and its output meets the minimum power requirements 5V/1A.
- If there is no Type-A port on your computer, use the Type-C Adapter.
- The scanner is powered when the INSPIRE's power indicator turns solid green.

5

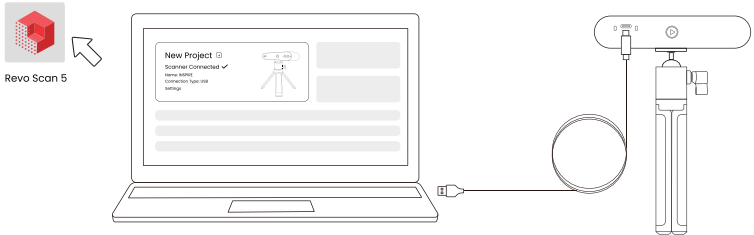

- Open Revo Scan 5 to see if the scanner connected successfully.
- To learn how to connect INSPIRE to a PC via Wi-Fi, please check out the User Manual on Revopoint's official website.

Connect INSPIRE to a Phone via Wi-Fi

1

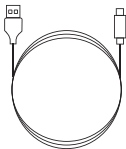

USB Type-A to C Cable



2

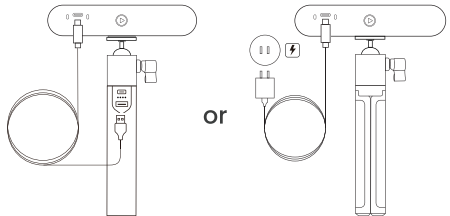

or

- To use the Wi-Fi connection, the scanner must be powered by a power bank or power outlet. Do not plug into your PC, or it will be in USB mode by default.
- The Power Bank Handle is sold separately. You can use your own power bank if it's rated 5V/1A or power it with an outlet.
- The scanner is powered when the INSPIRE's power indicator turns solid green.

3

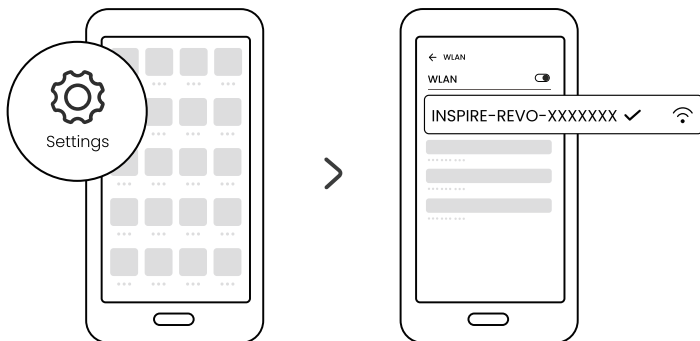

- Go to your smartphone's Wi-Fi settings, search for the network called **INSPIRE-REVO-XXXXXXX**, and connect (No password is required).
- Wait a few seconds for the scanner to connect.

4

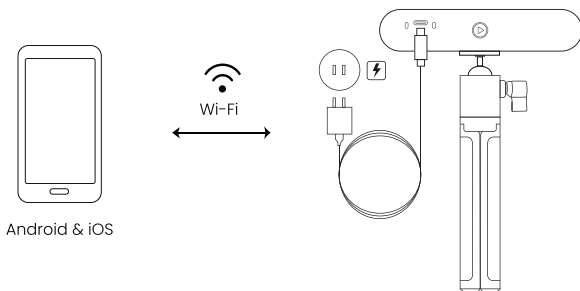

5

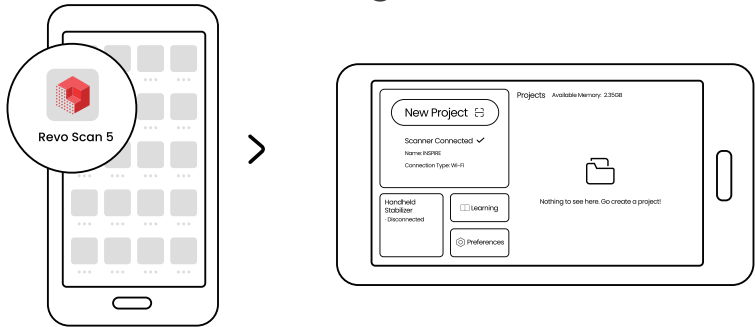

- Both Android and iOS phones can connect to INSPIRE via Wi-Fi.
- To learn how to connect INSPIRE to a smartphone via USB, please check out the User Manual on Revopoint's official website.

Mini Turntable Connection

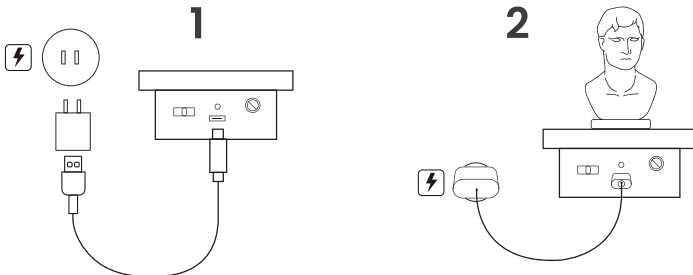

- AC Adapter is not included.
- The Mini Turntable's indicator turns solid green when powered. Then, move the switch left or right to adjust rotation direction and twist the dial to adjust the rotation speed.

3

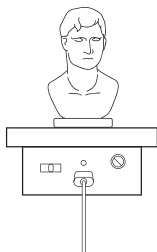
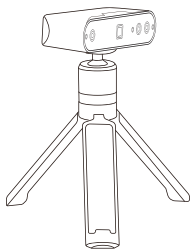

Setup the Scanning Environment

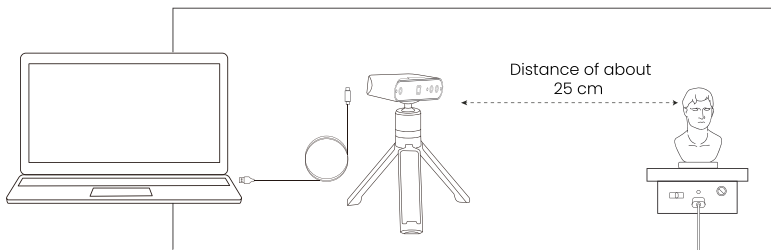

- Power on the turntable and adjust it to its maximum speed.
- Put Sample Bust on the turntable.
- Connect the scanner to a PC and attach it to its tripod. Angle the scanner toward the Sample Bust bust and slightly above it.
- The scanner is angled down towards the object at a distance of about 25 cm.
- Use the Magic Mat or a black bin bag as the background.
- Check the Sample Bust to ensure that there are no shadows on its surface and that the overall lighting is even and bright.

Introduction to Revo Scan 5

Scanning Workflow



Scan Preview: Click the “New Scan” button to preview the scan and adjust the scan’s settings.

Start: Click the “Start” button to begin the scan.

Pause: Click the “Pause” button to pause and check the scan.

Complete: Click the “Complete” button to finish the scan.

Cancel: Click the “Cancel” button to cancel the scan and clear the captured data.

1. New Scan

Adjust settings in the scan preview interface.

① Scan Settings

Accuracy

Standard Accuracy: The post-processing time will be longer, but the results are more suitable for applications needing more detail.

High-speed (18 fps): The frame rate can be up to 18 fps, and the scanner can quickly capture an object’s 3D data.

Tracking Mode

Feature Tracking: Used to scan objects with detailed, distinct features, like the sample bust.

Marker Tracking: Used to scan objects with simple geometric features, like the basketball or bowl.

Object Type

General Object: Used to scan most objects with distinct features.

Dark Object: Used to scan objects with dark surfaces or distinct surface color contrasts.

Face: Used to scan people’s faces.

Body: Used to scan the entirety of the body, from the upper and lower regions to the limbs and hair.

Color Scanning

Toggle Color Scanning: The scanner captures the color and shape information of the object when scanning. [Texture Mapping] can be applied during post-processing.

Untoggle Color Scanning: The scanner only captures the shape information of the object when scanning. [Texture Mapping] is not supported during post-processing.

② Distance Adjustment



Move the scanner or object to adjust the distance between them. When the scanning distance indicator bar displays green, the scan distance is at an optimal range.

③ Depth Cameras' Exposure Settings

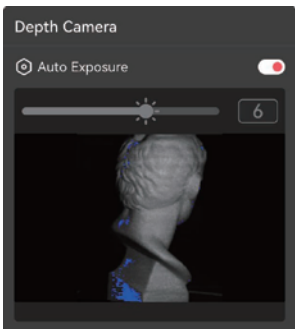

- Ensure only the scanned object is shown in the depth cameras' preview window. Use the Magic Mat or a black bin bag if necessary.
- Drag the slider bar to increase or decrease exposure.
- If there are large red areas on the object, it indicates overexposure. If there are large blue areas on the objects, it indicates underexposure.

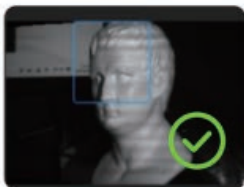

Correct Exposure



Underexposed



Overexposed

④ RGB Camera Exposure Settings

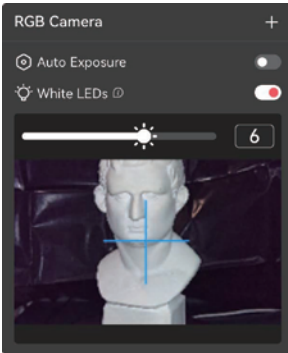

- Adjusting the RGB camera's exposure is crucial for color scanning.
- Use the blue crosshair as a reference point to aim at the object.
- Toggle or untoggle [White LEDs] as required.
- Drag the slider bar to adjust the RGB camera's exposure. See the examples below:



Correct Exposure



Underexposed

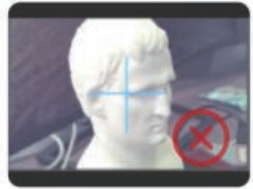

Overexposed

2. Start

Start scanning when all settings are correct.

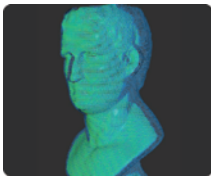

- Blue shows the already scanned area, while green shows the area currently seen by the scanner.
- For handheld scanning, slowly and steadily move the scanner around the object to prevent tracking loss.

Scanning Errors



If a “tracking lost” notification appears during scanning, re-target the scanner to a previously scanned area (blue) with plenty of distinct features. Keep it still for several seconds to re-acquire tracking. When the red portion of the display changes to green, resume scanning.

During scanning, click the Start  / Pause  button as required to adjust the model.

If you want to cancel the scan after starting, click the Cancel  button.

3. Complete

Complete scanning after all data is captured.

To export the model, please perform point cloud fusion first.

Post-processing

Raw Data

The unprocessed and unfiltered data points captured during the scanning process. It cannot be exported.



Point Cloud

Combine datasets captured by both depth cameras into a complete point cloud dataset. It can be exported in the PLY or OBJ formats.



Mesh

Create a 3D model with the captured point cloud data. It can be exported in PLY, OBJ, or STL formats.



Texture

Apply textures or color information to the mesh. It can be exported in PLY or OBJ formats.

Export the Model

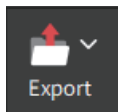

Export the point clouds, mesh model, or texture model file.

IC Warning

This device complies with Industry Canada's licence-exempt RSS standard(s). Operation is subject to the following two conditions:

- (1) this device may not cause interference, and
- (2) this device must accept any interference, including interference that may cause undesired operation of the device.

This Class B digital apparatus complies with Canadian ICES-003.

IC RF Statement:

When using the product, maintain a distance of 20cm from the body to ensure compliance with RF exposure requirements.

FCC Warning

This device complies with part 15 of the FCC Rules. Operation is subject to the following two conditions:

- (1) This device may not cause harmful interference, and
- (2) this device must accept any interference received, including interference that may cause undesired operation.

Any Changes or modifications not expressly approved by the party responsible for compliance could void the user's authority to operate the equipment.

Note: This equipment has been tested and found to comply with the limits for a Class B digital device, pursuant to part 15 of the FCC Rules. These limits are designed to provide reasonable protection against harmful interference in a residential installation. This equipment generates uses and can radiate radio frequency energy and, if not installed and used in accordance with the instructions, may cause harmful interference to radio communications. However, there is no guarantee that interference will not occur in a particular installation. If this equipment does cause harmful interference to radio or television reception, which can be determined by turning the equipment off and on, the user is encouraged to try to correct the interference by one or more of the following measures:

- Reorient or relocate the receiving antenna.
- Increase the separation between the equipment and receiver.
- Connect the equipment into an outlet on a circuit different from that to which the receiver is connected.
- Consult the dealer or an experienced radio/TV technician for help.

This equipment complies with FCC radiation exposure limits set forth for an uncontrolled environment.

This equipment should be installed and operated with minimum distance 20cm between the radiator & your body.

Online Support

WE ARE HERE FOR YOU



Contact Revopoint
Tech Support



Contact Revopoint
Customer Support

SUBSCRIBE FOR MORE INFO



This content is subject to change.

COPYRIGHT © 2023 REVOPOINT 3D ALL RIGHTS RESERVED.

REVOPOINT